

Vertical ladders

**H
Y
M
E
R**

**MADE FOR
PEOPLE WHO
GET THINGS DONE.**

Customise your vertical ladder system quickly and easily.

With our vertical ladders, you can create permanent access that is also safer, even at great heights. Designed and manufactured in Germany, our vertical ladders impress with their high quality in every detail. For your daily safety. True to our claim: HARD WORK MADE EASY.

- ✔ **Support when measuring the vertical ladder**
- ✔ **Comprehensive consultation**
- ✔ **Joint on-site visit**

**MADE FOR
PEOPLE WHO
GET THINGS DONE.**

VERTICAL LADDER OVERVIEW

The vertical ladder needs to be selected according to which standard?



Norm	DIN 18799-1 DIN 18799-3	DIN 14094-1	DIN EN ISO 14122-4
Application	As maintenance ladder for a building	As emergency ladder, fire escape or escape route	As access to machines and machinery (also in buildings as part of a production facility)
Max. permissible total access height (S)	unlimited	unlimited	unlimited
Safety cage required from total access height (S)	$S > 3.0$ m	$S > 3.0$ m	$S > 3.0$ m
Distance from the ground to the start of safety cage	2.2 – 3.0 m	2.2 – 3.0 m	2.2 – 3.0 m
Max. length of ladder section	10.0 m	6.0 m for $S > 10.0$ m 10.0 m for $S \leq 10.0$ m	6.0 m for $S > 10.0$ m 10.0 m for $S \leq 10.0$ m
Max. distance between resting platforms / offset platforms	10.0 m	6.0 m	6.0 m
Special features	exit with barrier and guardrail required	lockable access not permitted	exit with barrier and guardrail required
Alternative fall arrest (fall arrest rail)	possible	not possible	possible

HYMER ONLINE – THE VERTICAL LADDER CONFIGURATOR

Easily configure your product now.

Our configurator allows you to put together customised vertical ladder systems quickly and easily. All information provided will be checked to ensure compliance with standards. This means you can rest assured that your project will meet all requirements set out by the applicable standard.

01 Select product.

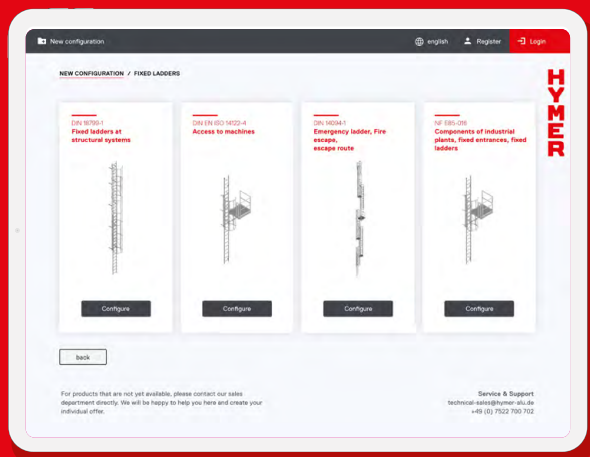

Four standard-compliant vertical ladder types are available: for structural systems, machines, escape routes and industrial systems.

02 Configure product features.

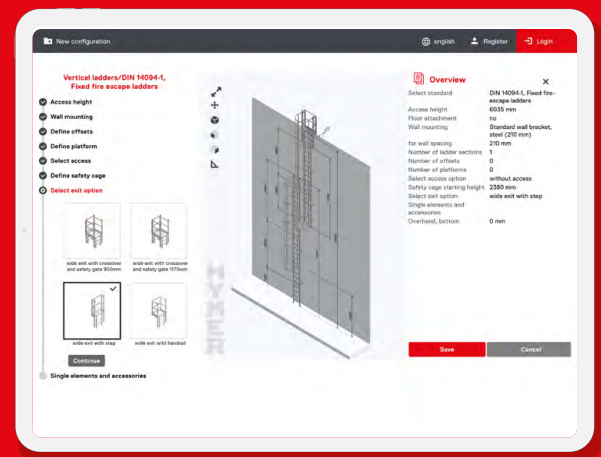

User-friendly configuration in just a few steps: Enter the access height (suitable back protection is displayed automatically), specify the platform, select the entry form, specify the exit variant and then select the individual elements/accessories.

03 Display detailed quote.

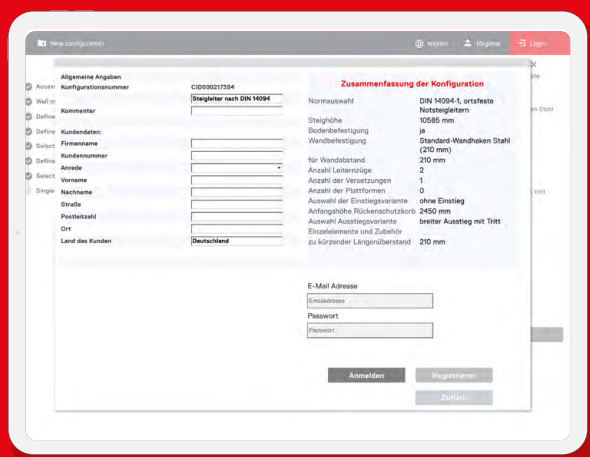

The configuration can be saved and retrieved at a later time. With just one click, a quote is created for instant viewing and you can easily place your order online.

04 Have the vertical ladder delivered.

Your order will be processed immediately and your new vertical ladder solution will be delivered swiftly.

Your way to receiving 3D data (.stp format) is simple – just indicate us your CID-configuration number – and shortly afterwards you can continue with the integration in your planning program.

Configure your own vertical ladder now!

hymer-configurator.com

NOW ALSO AVAILABLE IN YOUR COLOUR

We also offer our vertical ladders powder-coated in your RAL colour. Please contact our HYMER sales team, indicating your configuration number, RAL colour and surface!

VERTICAL LADDERS

Compliant quality and maximum safety delivered as quickly as possible.

For structural systems, machinery and industrial systems, as an escape route or fixed access: Our vertical ladder systems provide 100% compliance with standards and certified quality assurance. High availability and optimised ordering processes mean we deliver quickly and reliably.

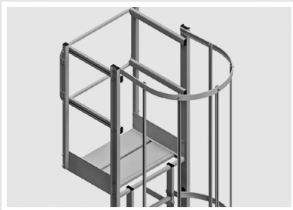

Various exit variants can be selected, such as exit with crossover, step, handrail or access aid.

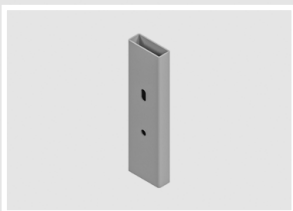

Simple connections with screw-on ladder connectors.

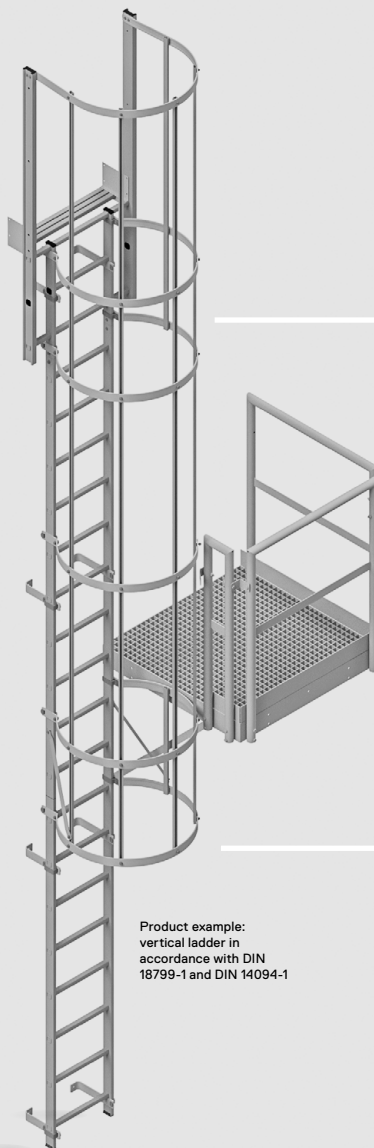

Product example:
vertical ladder in
accordance with DIN
18799-1 and DIN 14094-1

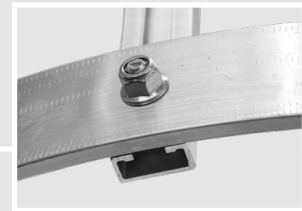

Quick and easy assembly using C-profiles. Later vertical shifting possible.

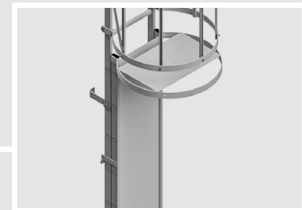

Individually selectable access with various locking options.

hymer-configurator.com

DIN
18799-1

DIN
18799-3

DIN
14094-1

ISO
14122-4

10
YEAR
GUARANTEE

★ ★ ★
MADE IN
GERMANY

NECESSARY INFORMATION

Facade structure/cross-sections

Example 1: direct mounting on the facade

- **Wall thickness (Z)**

Type of facade (concrete, solid brick, perforated brick, wood, trapezoidal sheet metal, sandwich panels, etc.)



Example 2: Installation on curtain wall

- **Wall thickness of the load-bearing wall (Z)**

Type of load-bearing wall (concrete, solid brick, perforated brick, wood, trapezoidal sheet metal, sandwich panels, etc.)

- **Thickness of insulation layer (Y)**

Type of insulation layer (mineral fibre, insulation panels, layer of air)

- **Curtain wall thickness (X)**

Type of curtain wall (solid brick, perforated brick, wood, trapezoidal sheet metal, sandwich panels, etc.)

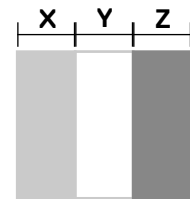

Facade features

This information is important for using the appropriate wall brackets.

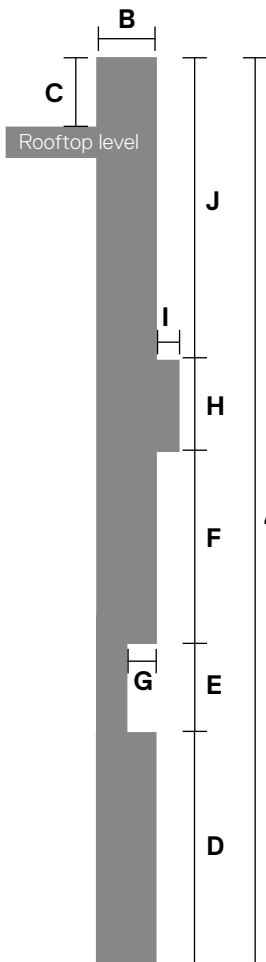

A Vertical climbing height (floor to top of access height)

B Fascia width (omitted if roof level is at the same height)

C Height difference (upper edge of access height to upper edge of roof level)

D Vertical height to first offset
In the event of further offsets, always use the respective intermediate dimensions specify (E | F | G | H | I | J).

Important: Indication whether offset is inwards or outwards.

I Other dimensions
Dimensions are also required for components such as gutters, etc.

This information is important for the correct mounting position.

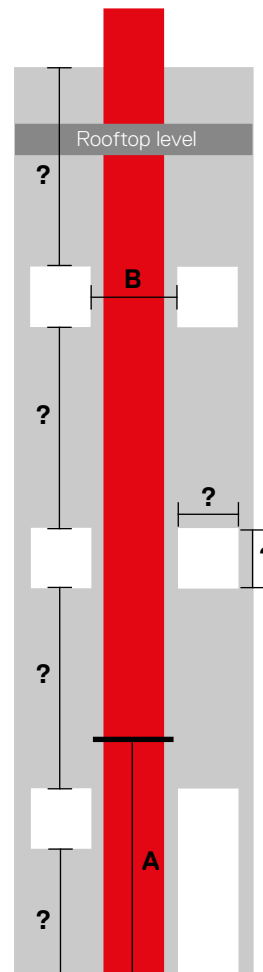

Example sketch of a single-section vertical ladder

Vertical access height approx. 8.20 m

For access heights above 10 m, the vertical ladder should be installed using several staggered sections.

A Desired dimension of lower edge of safety cage (2.20 to 3.00 m)

B Minimum width 800 mm
(Please note: exterior lighting, cable ducts, etc.)
For escape ladders, please specify the position of the exit platforms.

DIN 18799-1 / DIN 18799-3 (ACCESORIES) LADDER FOR MAINTENANCE OF A BUILDING

Continuous fall
protection on
request

- The top rung must be at the exit level.
- From an access height of 10,000 mm, the ladder must be installed with offset. The maximum length of a ladder section must not exceed 10,000 mm.
- The offsets are to be positioned at equal intervals, but can also be planned at different heights using the online configurator.
- Distance of the rung-leading-edge of the ladder must be at least 200 mm, but may be reduced to 150 mm in the event of obstacles (e.g. pipes).
- When using access protection (individual fall protection), the use of the vertical ladder system must only be carried out by experienced persons.

Exception:

If offsets are not possible for structural reasons, the ladder may also have a single-section longer than 10,000 mm. In this case, the offset must be replaced with a resting platform.

Exit:

- The gap between the vertical ladder and the exit level must not exceed 75 mm. For a standard wall distance between ladder and building of 210 mm, this 75 mm gap is provided by using an exit step.
- Unsecured exit areas must be equipped with a lateral guardrail or a railing on both sides towards the roof area.

Fastening:

- The standard wall mounting has a gap of 210 mm from the stile axis to the building.
- The distance between the individual fastening points must not exceed 2,000 mm. They should preferably be attached directly below the rungs.

Safety cage:

- Distance from the lowest safety cage clamp to the floor: 2,200 mm to 3,000 mm.
- Safety cage required from a height of 3,000 mm.

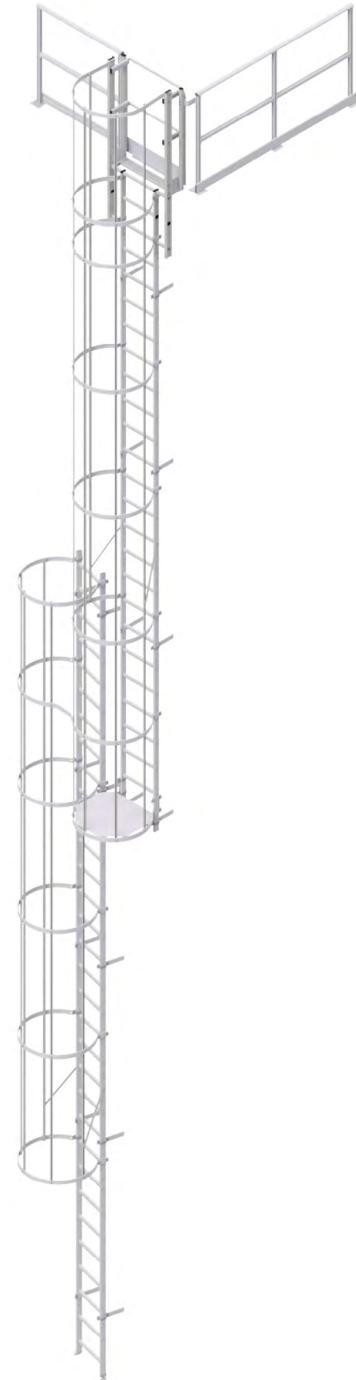

DIN 14094-1

ESCAPE LADDER / FIRE ESCAPE / ESCAPE ROUTE

- From an access height of 10,000 mm, the ladder must be installed with offset. The max. length of a ladder section must not exceed 6,000 mm.
- The top rung must be at the exit level.
The offsets are to be positioned at equal intervals, but can also be planned at different heights using the online configurator.
- The distance from the rung-leading-edge to the wall must be at least 150 mm.

Exit:

The gap between the vertical ladder and the exit level must not exceed 75 mm. For a standard wall distance between ladder and building of 210 mm, this gap is provided by using an exit step.

Fastening:

- The standard wall mounting has a gap of 210 mm from the stile axis to the building.
- The distance between the individual fastening points must not exceed 2,000 mm. They should preferably be attached directly below the rungs.

Safety cage:

- Distance from the lowest safety cage clamp to the floor: 2,200 mm to 3,000 mm.
- Safety cage required from a height of 3,000 mm.



EN ISO 14122-4

MAINTENANCE LADDER FOR MACHINE SYSTEMS

Continuous fall protection on request

- The topmost rung must end at the level of the exit area.
- From an access height of 10,000 mm, the ladder must be installed with offset. The maximum length of a ladder section must not exceed 6,000 mm.
- The offsets are to be positioned at equal intervals, but can also be planned at different heights on request or by using the online configurator.
- Distance of the rung-leading-edge of the ladder must be at least 200 mm, but may be reduced to 150 mm in the event of obstacles (e.g. pipes).

Exit:

- According to EN ISO 14122-4, the exit point must meet the highest safety requirements. The exit must be secured with a self-closing safety gate. The gap between ladder and building must not exceed 75 mm. For a standard wall distance between ladder and building of 210 mm, this 75 mm gap is provided by using an exit step.
- The exit stile must be connected to a guardrail which is 1,500 mm long on both sides of the exit surface.
- Our supplied guardrail can also be dispensed with if there is an option of connecting to a guardrail provided by the customer.

Fastening:

- The standard wall mounting has a gap of 210 mm from the stile axis to the building.
- The distance between the individual fastening points must not exceed 2,000 mm. They should preferably be attached below the rungs.

Safety cage:

- Distance from the lowest safety cage clamp to the floor: 2,200 mm to 3,000 mm.
- Safety cage required from a height of 3,000 mm.



DIN 18799-1

Access height in mm	Ladder length in mm (20000904, 20000907, 20000909)			Number of wall brackets (0051568)	Number of safety cage clamps (0051600)	Number of ladder connectors (20001022)	Number of safety cage braces (002272)	CID
	1,960	2,800	3,640					
5,475	1	1	-	8	3	1	10	CID000237986
6,315	-	2	-	8	4	1	10	CID000237996
7,155	-	1	1	10	5	1	10	CID000237997
7,995	-	-	2	10	5	1	15	CID000237998
9,115	-	3	-	12	6	2	15	CID000237999
9,955	1	-	2	12	7	2	15	CID000238000

Individual parts required:

1 x 0054050 safety cage clamp for exit wide, 1 x 0053340 diagonal brace, 1 x 0053298 wide exit with step, 1 x 0053335 left guardrail for exit, 1 x 0053335 right guardrail for exit, 1 x 21000012 user manual and assembly instructions and, if necessary, 5 or 10 x 0050255 connector for safety cage braces

DIN 14094-1

Access height in mm	Ladder length in mm (20000904, 20000907, 20000909)			Number of wall brackets (0051568)	Number of safety cage clamps (0051600)	Number of ladder connectors (20001022)	Number of safety cage braces (002272)	CID
	1,960	2,800	3,640					
5,475	1	1	-	8	3	1	10	CID000238189
6,315	-	2	-	8	4	1	10	CID000238190
7,155	-	1	1	10	5	1	10	CID000238191
7,995	-	-	2	10	5	1	15	CID000238192
9,115	-	3	-	12	6	2	15	CID000238193
9,955	1	-	2	12	7	2	15	CID000238194

Individual parts required:

1 x 0054050 safety cage clamp for exit wide, 1 x 0053340 diagonal brace, 1 x 0053292 wide straight exit, 1 x 0054039 wide exit step, 1 x 21000012 user manual and assembly instructions and, if necessary, with 5 or 10 x 0050255 connector for safety cage braces

EN ISO 14122-4

Access height in mm	Ladder length in mm (20000904, 20000907, 20000909)			Number of wall brackets (0051568)	Number of safety cage clamps (0051600)	Number of ladder connectors (20001022)	Number of safety cage braces (002272)	CID
	1,960	2,800	3,640					
5,475	1	1	-	8	3	1	10	CID000238003
6,315	-	2	-	8	4	1	10	CID000238004
7,155	-	1	1	10	5	1	10	CID000238006
7,995	-	-	2	10	5	1	15	CID000238178
9,115	-	3	-	12	6	2	15	CID000238179
9,955	1	-	2	12	7	2	15	CID000238181

Individual parts required:

1 x 0054050 safety cage clamp for exit wide, 1 x 0053340 diagonal brace, 1 x 0053298 wide exit with step, 1 x 21000012 user manual and assembly instructions and, if necessary, 5 or 10 x 0050255 connector for safety cage braces

INDIVIDUAL ELEMENTS FOR VERTICAL LADDERS

14 Individual elements – Ladder sections and accessories

15 Individual elements – Wall mountings

16 Individual elements – Accesses

17 Individual elements – Exits

18 Individual elements – Accessories for exits

19 Individual elements – Safety cage

21 Individual elements – Platforms

INDIVIDUAL ELEMENTS – LADDER SECTIONS AND ACCESSORIES



Ladder section

- Stiles and non-slip rungs made of high quality extruded profiles.
- Torsion-resistant due to the flanged stile-rung connection.

Material	alu	alu	alu
Number of rungs	2	4	5
Length (approx. mm)	560	1,120	1,400
Rung size (approx. mm)	30×30	30×30	30×30
Stile size (approx. mm)	60×24	60×24	60×24
Rung distance (approx. mm)	280	280	280
Outer width (approx. mm)	448	448	448
Inner width (approx. mm)	400	400	400
Order no.	20000905	20000906	20000908

Material	alu	alu	alu
Number of rungs	7	10	13
Length (approx. mm)	1,960	2,800	3,640
Rung size (approx. mm)	30×30	30×30	30×30
Stile size (approx. mm)	60×24	60×24	60×24
Rung distance (approx. mm)	280	280	280
Outer width (approx. mm)	448	448	448
Inner width (approx. mm)	400	400	400
Order no.	20000904	20000907	20000909

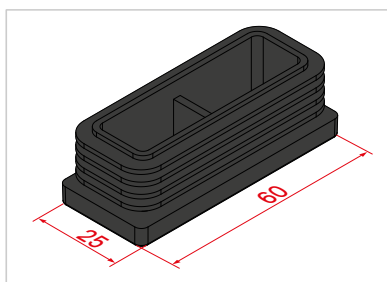

Ribbed plug

- For covering the ends of stiles.
- Made of polyethylene (PE).

Length (approx. mm)	60
Width (approx. mm)	25
Material	plastic
Order no.	0077059



Ladder connectors set

- For connecting two ladder sections.

Quantity	2 pieces
Height (approx. mm)	100
Width (approx. mm)	57.2
Material	alu
Order no.	20001022

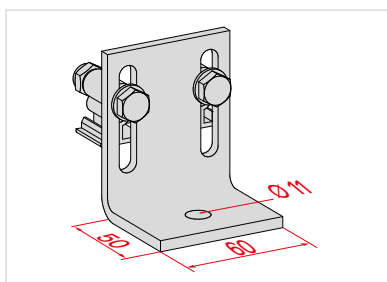

Floor bracket

- For fastening ladder parts on the floor.
- Including nut and bolt for ladder assembly. Without screws for ground attachment.

Material	alu	alu
Type	rigid	adjustable
Adjustment range (approx. mm)	–	40
Order no.	0051566	0053451

INDIVIDUAL ELEMENTS – WALL MOUNTINGS

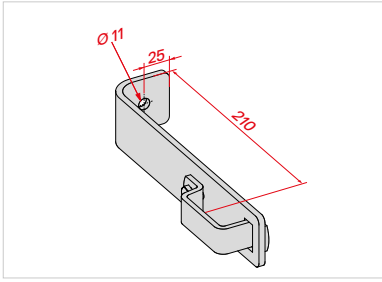

Standard wall hook

- For fastening ladder parts on the wall.
- Without screws for wall attachment.

Material	alu/steel	steel
Size (approx. mm)	210	210
For stile size (approx. mm)	60×24	60×24
Order no.	0050139	0051568

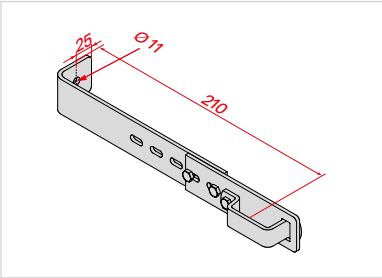

Adjustable wall hook

- For fastening ladder parts on the wall.
- Without screws for wall attachment.

Material	steel
Adjustment range (approx. mm)	172–300
For stile size (approx. mm)	60×24
Order no.	0051572

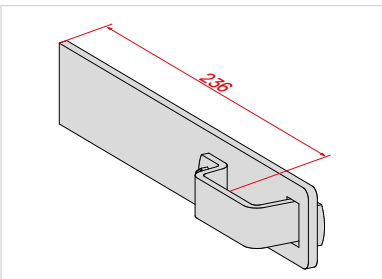

Straight wall mounting

- For fastening ladder parts on the wall.

Material	alu	steel
For stile size (approx. mm)	60×24	60×24
Size (approx. mm)	236	236
Order no.	0050141	0051569

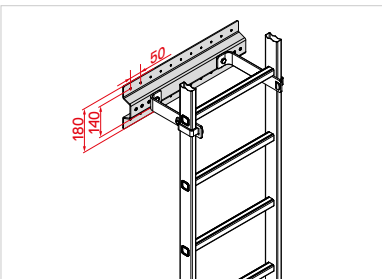

Facing plate

- For mounting wall hooks to sheet metal facades.
- Facing plate with rubber seal strip incl. screws and nuts for mounting wall hooks on the facade panels. Without screws for fastening on façades (must be done on site).

Material	alu
Order no.	0055096

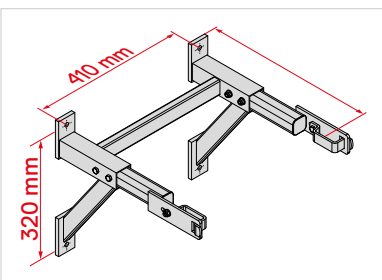

Adjustable wall bracket

- For fastening ladder parts on the wall.
- Without screws for wall attachment.

Material	alu	alu	alu	alu
Adjustment range (approx. mm)	300–400	350–500	500–650	650–800
For stile size (approx. mm)	60×24	60×24	60×24	60×24
Order no.	0055021	0053320	0053321	0053322

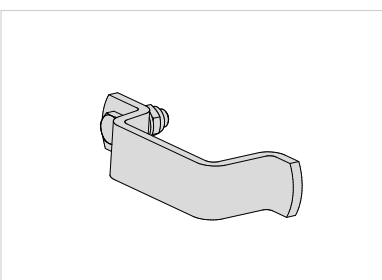

Clamp

- For securing the ladder parts on safety cage clamps or wall brackets.
- For safety cage clamp and wall mounting.
- Including screw and nut.

Material	steel
Order no.	0053946

Note: The distance between the individual fastening points must not exceed 2,000 mm. The fasteners should preferably be attached below the rung (max. 1,960 mm).

INDIVIDUAL ELEMENTS – ACCESSES

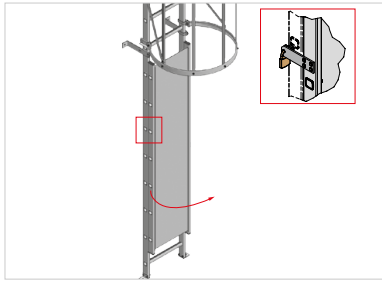

Access barrier, lockable

- Secures vertical ladders against use by unauthorised persons.
- Opening to the left.
- Including padlock.

Material	alu
Length (approx. mm)	1,900
Order no.	0051637

DIN
18799-1

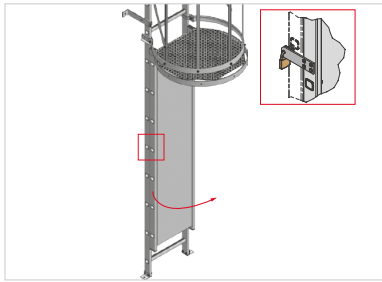

Access barrier with cover, lockable

- Secures vertical ladders against use by unauthorised persons.
- Opening to the left.
- Including padlock.

Material	alu
Length (approx. mm)	1,900
Order no.	0051764

DIN
18799-1

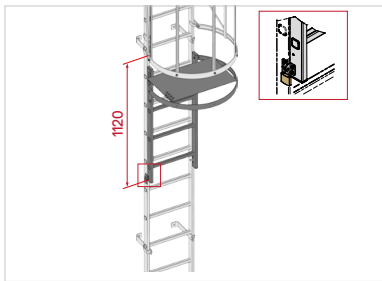

Access barrier

- Secures vertical ladders against use by unauthorised persons.
- Swivelling ladder section with platform.
- Opening to the left.
- Including padlock.

Material	alu
Order no.	0054770

DIN
18799-1



Access, retractable with rope operation

- Ladder section can be released with the aid of a rope-pull from top and bottom.
- The corresponding section of the safety cage (height 1,730 mm) is included.
- Max. access height 2,800 mm.

Material	alu
Rope operation from	top and bottom
Length retracted/extended (approx. mm)	3,660/4,780
Order no.	0055592

DIN
18799-3

ISO
14122-4



Emergency ladder

- Access protection with automatic release when stepping on the top rung.
- Can be used for escape ladders from an access height of 6.20 m.
- The corresponding section of the safety cage (height 1,730 mm) is included.
- Max. access height 2,800 mm.

Material	alu
Length retracted/extended (approx. mm)	3,660/4,780
Order no.	0055591

DIN
14094-1

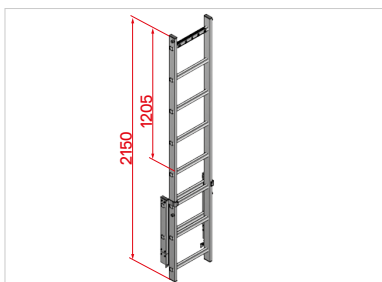

Extendable access aid

- For use with skylights, shafts and pits.

Material	alu
Length (approx. mm)	2,150
Order no.	0053345

INDIVIDUAL ELEMENTS – EXITS

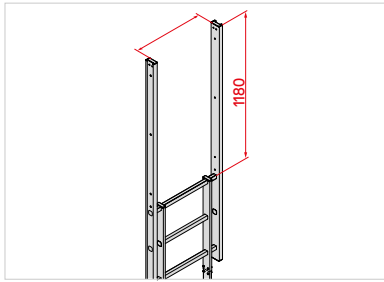

Straight exit

- In accordance with DIN 18799-1 for physical structures: Additional exit step (order no. 0054038 or 0054039) required.

Material	alu	alu
Width (approx. mm)	560	700
Order no.	0053291	0053292

DIN
14094-1

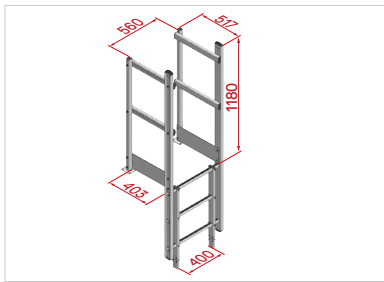

Narrow exit with handrail

- In accordance with DIN 18799-1 for physical structures: Additional exit step (order no. 0054038) required.

Material	alu
Order no.	0054054

DIN
14094-1

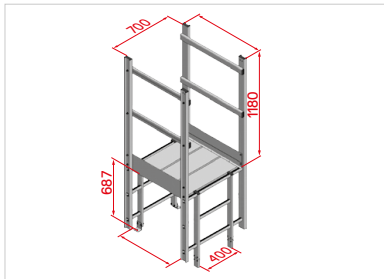

Wide exit with crossover

- Platform tread made of grooved aluminium, closed.
- Guardrails on both sides with handrail, knee rail and toeboard.

Material	alu	alu	alu
Length (approx. mm)	725	950	1,175
Clear platform length (approx. mm)	651	876	1,101
Order no.	0054056	0054057	0054058

DIN
18799-1

DIN
14094-1

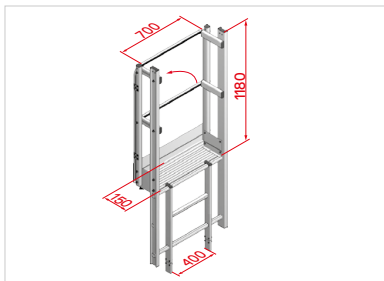

Wide exit with step

- Self-closing safety gate with handrail, knee rail and toeboard.
- Opening to the left.

Material	alu
Step depth of exit step (approx. mm)	150
Order no.	0053298

DIN
18799-1

DIN
14094-1

ISO
14122-4

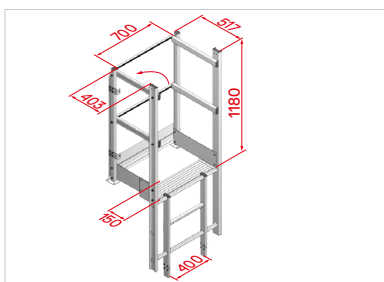

Wide exit with handrail

- Guardrail on both sides and self-closing barrier with handrail, knee rail and toeboard.
- Opening to the left.

Material	alu
Step depth of exit step (approx. mm)	150
Order no.	0054055

DIN
18799-1

DIN
14094-1

ISO
14122-4

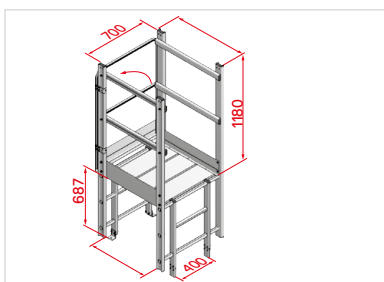

Wide exit with crossover and barrier

- Platform tread made of grooved aluminium, closed.
- Guardrail on both sides and self-closing barrier with handrail, knee rail and toeboard.
- Opening to the left.

Material	alu	alu	alu
Length (approx. mm)	725	950	1,175
Clear platform length (approx. mm)	651	876	1,101
Order no.	0054059	0054060	0054061

DIN
18799-1

DIN
14094-1

ISO
14122-4

INDIVIDUAL ELEMENTS – ACCESSORIES FOR EXITS

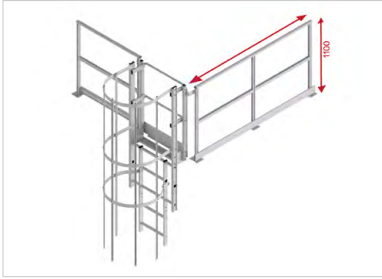

Guardrail for exit

- For securing the exit and entry point according to DIN 18799-3 and ISO 14122-4.
- For standard-compliant use according to DIN 18799-3, the 2,000 mm guardrail (order no. 0055534) must be used in the exit direction.
- Both lengths are possible for mounting laterally to the exit.
- Note: The guardrail can be combined with all exits except straight exit (order no. 0053291/0053292).

Material	alu	alu
Length (approx. mm)	1,090	2,000
Height (approx. mm)	1,100	1,100
Order no.	0055533	0055534

DIN
18799-3

ISO
14122-4

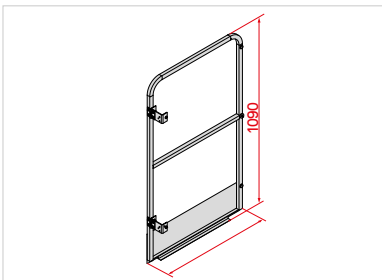

Barrier

- For protection against falling from vertical ladders.
- Self-closing barrier with handrail, knee rail and toeboard.
- With magnetic catch.
- Opening to the left.

Material	alu	alu
Type	narrow	wide
Outer width (approx. mm)	632	772
Height (approx. mm)	1,090	1,090
Order no.	0054032	0054033

ISO
14122-4

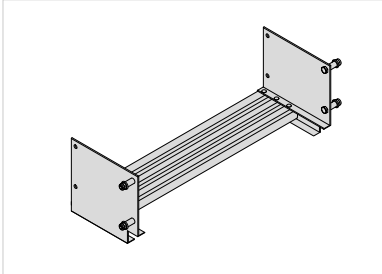

Exit step

- Including fastening material.

Material	alu	alu
Type	narrow	wide
Width (approx. mm)	560	700
Step depth of exit step (approx. mm)	150	150
Order no.	0054038	0054039

INDIVIDUAL ELEMENTS – SAFETY CAGE



Safety cage clamp 3/4

- Hammer head bolts for safety cage braces preassembled.
- Including fastening material.

Material	alu
Order no.	0053981

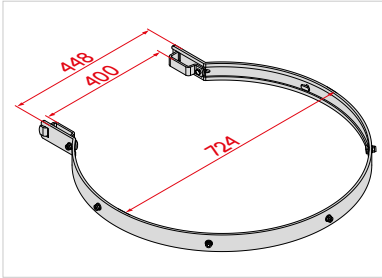

Safety cage clamp

- Hammer head bolts for safety cage braces preassembled.
- Including fastening material.

Material	alu
Diameter (approx. mm)	724
Order no.	0051600

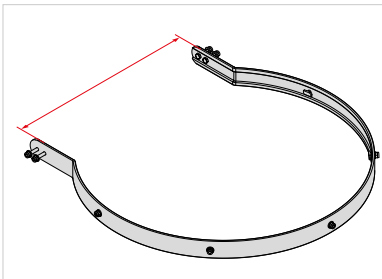

Safety cage clamp for exit

- Hammer head bolts for safety cage braces preassembled.
- Including fastening material.

Material	alu	alu
For exit	narrow	wide
Exit width (approx. mm)	560	700
Order no.	0054051	0054050



Diagonal brace

- For the stabilisation of the safety cage.
- Including fastening material.
- Note: Diagonal brace is required once per ladder section for vertical ladders with safety cages.

Material	alu
Order no.	0053340

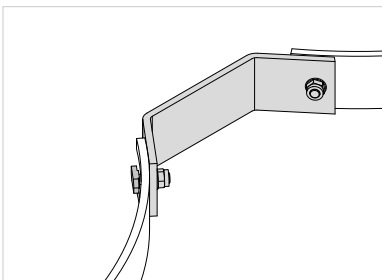

Connection for double clamp

- For connecting two safety cage clamps 3/4.

Material	alu
Order no.	0053332

Total length of safety cage =

access height – height from the ground to the start of the safety cage + length of the exit (always 1,180 mm)

INDIVIDUAL ELEMENTS – SAFETY CAGE

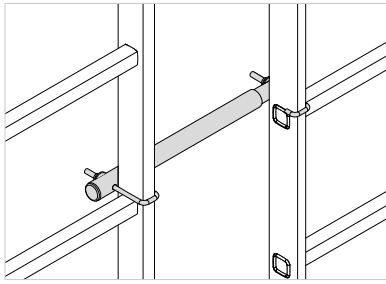

Handrail for offset

- For safely grasping between stiles when changing between multi-section ladders.
- Prescribed for access to machinery systems in accordance with EN ISO 14122-4.

Material	alu
Adjustment range (approx. mm)	305–480
Order no.	0055196

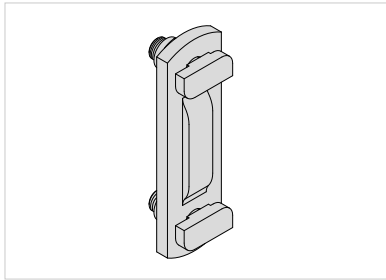

Connector for safety cage braces

Material	alu
Order no.	0050255

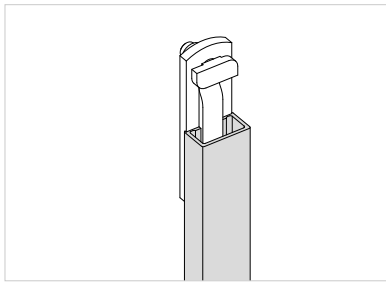

Safety cage brace

Material	alu
Length (approx. mm)	3,190
Order no.	002272

AN OFFSET COMPRISES:

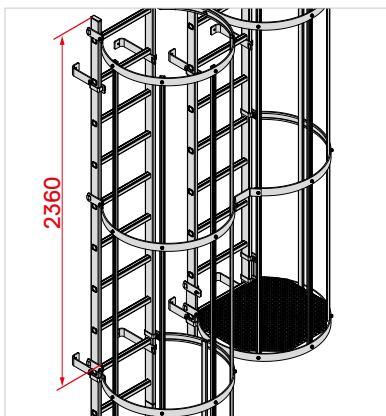

Description	Order no.	Quantity	Offset
Ladder section	div.	1	2,520 mm
Wall mounting	div.	4	
Safety cage clamp	0051600	1	
Safety cage clamp 3/4	0053981	2	
Diagonal brace	0053340	1	
Connection for double clamp	0053332	1	
Safety cage brace	002272	4	2,290 mm
Handrail for offset	0055196	1	
Fixed platform	0051630	1	

This parts list contains all components that are additionally required to offset a ladder section to the side.

INDIVIDUAL ELEMENTS – PLATFORMS

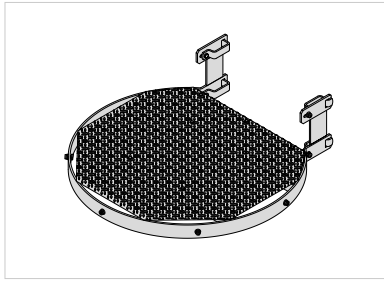

Fixed platform

- As a platform for offsets.
- Aluminium chequer plate tread.

Material	alu
Order no.	0051630

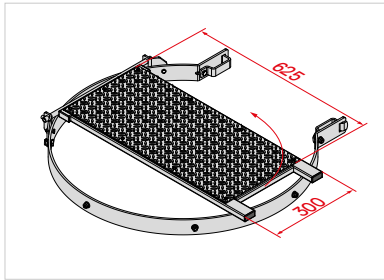

Folding intermediate platform

- For use as a resting platform, standing platform, etc. if an offset is not possible for structural reasons.

Material	alu
Order no.	0051635

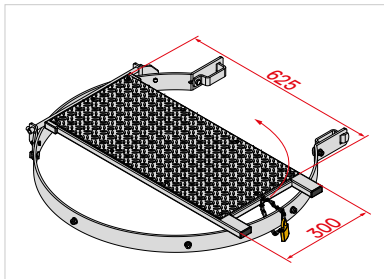

Folding intermediate platform, lockable

- For use as a resting platform, standing platform, etc. if an offset is not possible for structural reasons.
- Including padlock.
- Note: Not permitted for escape ladders in accordance with DIN 14094-1 and access to machines as stated by DIN 14122-4.

Material	alu
Order no.	0051762

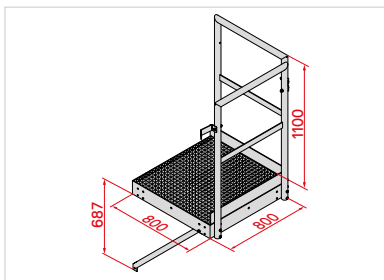

Platform

- Galvanised steel grating platform.
- Galvanised steel guardrail.

Material	steel	steel
Length (approx. mm)	800	1,000
Width (approx. mm)	800	1,000
Mesh size (approx. mm)	30x30	30x30
Order no.	0054040	0054041

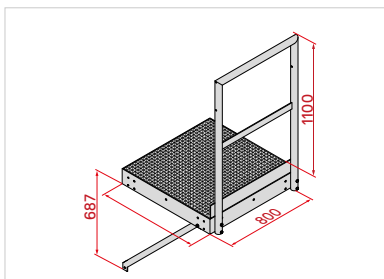

Extension platform

- Galvanised steel grating platform.
- Galvanised steel guardrail.

Material	steel	steel
Length (approx. mm)	800	1,000
Width (approx. mm)	800	800
Mesh size (approx. mm)	30x30	30x30
Order no.	0054042	0054043

PERSONAL FALL PROTECTION



The goal of using fall protection PPE is always to limit the fall height.

By incorporating a fall protection system into the PPE, you can safeguard workers from a wide range of hazards. For personal fall protection to work properly, the individual components of the restraint or fall arrest system must be precisely fine-tuned to each other. In addition, they must always be used as intended.

Our range of products include PPE that offers optimal wear comfort, smooth functionality, premium quality and a high level of safety – thus allowing you to safely access high places in your daily work. True to the motto: **Hard work made easy.**

FALL PROTECTION



Fall arrest rail

- Rail profile with connector, no attachment hardware: 50 x 30 mm.
- For retrofitting to existing ladders that do not have a fall arrest system.
- Recommended distance between brackets: max. 1,200 mm.

Length (approx. mm)	560	1,120	1,400
Material	steel	steel	steel
Weight (approx. kg)	1.2	2.3	2.9
Order no.	0055472	0055473	0055474

Length (approx. mm)	1,960	2,800	3,640
Material	steel	steel	steel
Weight (approx. kg)	4.0	5.8	7.5
Order no.	0055475	0055476	0055477



Fall arrest rail connector

- For connecting individual ladders or rail segments.

Size (approx. mm)	60x30
Material	steel
Colour	silver
Weight (approx. kg)	0.6
Order no.	0055483

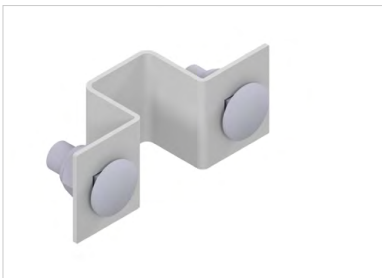

Mounting bracket

- Bracket for mounting the fall arrest rail to existing ladder systems.
- For 30 x 30 mm rungs.

Material	steel
Weight (approx. kg)	0.2
Order no.	0055478



Rest platform, foldable

- For attachment to the fall arrest rail.
- Should be installed every 10 metres.

Material	steel
Weight (approx. kg)	4.6
Order no.	0055479

FALL PROTECTION

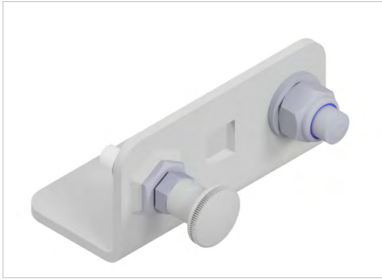

End stop

- Can be installed at both the top and bottom.
- Prevents the fall arrest device from being inserted incorrectly and from accidentally falling out of the fall arrest rail.

Material	steel
Colour	silver
Weight (approx. kg)	0,4
Order no.	0055481

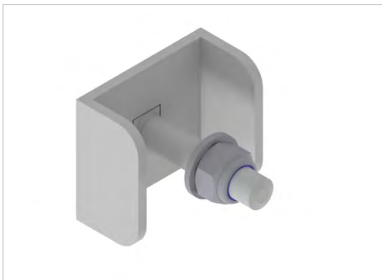

End stop, rigid

- Prevents the fall arrest device from being removed from the guide rail.

Material	steel
Colour	silver
Weight (approx. kg)	0,3
Order no.	0055480



Stile extension

- For safely exiting the ladder and stepping onto a flat roof.
- No end stop required.
- Exit can be swivelled by 180°.
- The top edge of the roof exit must be at least 1,000 mm above the top edge of the landing.
- The stile reinforcement must extend downwards through at least two mounting brackets.

Material	steel
Weight (approx. kg)	14,2
Order no.	0055482



Anchor point

- Single anchor point for fall arrest.
- For fixed installation (fastening point Ø 16 mm).
- Note: Hanging with a rope or other components is not permitted.

Material	steel, powder-coated
Max. number of users	3
Weight (approx. kg)	0,6
Order no.	0055487

FALL PROTECTION



Fall arrest slider

- With two redundant fall-arrest systems and speed-dependent fall-arrest function.
- Additional lever allows the slide to be used in lean-back mode when climbing, which reduces the injury caused by a fall.
- For use in conjunction with the fall arrest ring.

Material	alu/steel
Max. number of users	1
Weight (approx. kg)	1.1
Order no.	0055485

Note: For rescue purposes, a second fall arrest slider and PPE kit must be available close to the location.



Removable fall arrest slider

- Can be attached to and removed from any part of a C-profile.
- The dual safety mechanism prevents it from being attached incorrectly and from opening under load.
- Indicator to show device is securely engaged.
- Suitable for both lean-back and pull modes.

Material	alu/steel
Max. number of users	1
Permissible load (kg)	150
Temperature range (approx. °C)	45-30
Weight (approx. kg)	1.6
Order no.	0055486

Note: For rescue purposes, a second fall arrest slider and PPE kit must be available close to the location.

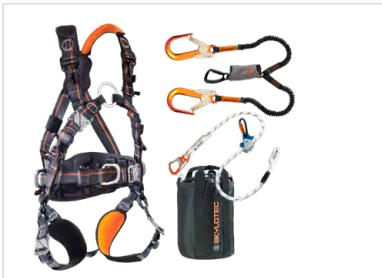

PPE kit

- State-of-the-art harness featuring click buckles, ergonomic padding, side D-rings and an attachment ring for fall protection.
- Shock absorber with tear-away mechanism that can reduce the fall-arrest force to 6 kN for loads of up to 140 kg, thereby staying within limits.
- Incl. practical transport bag.

Size	M / XXL
Weight (approx. kg)	7.1
Order no.	0055484

Note: For rescue purposes, a second fall arrest slider and PPE kit must be available close to the location.

Components:

- IGNITE PROTON WIND STEEL (G-1132-WS-ST-M/XXL)
- SKYSAFE PRO FLEX Y (L-0559-1,8)
- ERGOGRIP SK16 (L-0204-1,5)
- ROPE BAG (ACS-0009-3)

BASED IN THE ALLGÄU, LOCATIONS THROUGHOUT EUROPE.

60 years of excellent quality made in Germany.

Under the leadership of our founding family since day one, we are successful on the market as a stable company active throughout Europe. Because we don't settle for mediocrity, but constantly

question and re-define the accepted standards. This is how we create both stability and progress.



Milton Keynes, UK

Hamburg, DE

Weissenburg, FR

 **Wangen in
Allgäu, DE**

Tresdorf, AT

Montlingen, CH

Valladolid, ES

Hymer-Leichtmetallbau GmbH & Co. KG

Käferhofen 10 | 88239 Wangen | Germany

Telephone +49 75 22 700-702

technical-sales@hymer-alu.de | hymer-access.com

hymer-access.com

You can also download all
brochures from our website:



Written information on the products and images thereof may differ from the actual design in individual cases.
Errors, price changes and design modifications are also reserved.

Version: 04/2024